





UNIT CODE	DESCRIPTION
MED-RPS-G 160-24	160 Watt, 24 Volt, 5x3" PCB-Type, Open Frame, Single Output MOPP Level Medical Power Supply

SPECIFICATIONS		
AC Input	DC Output	Approvals
Universal AC input 90 ~ 264V	+24VDC @ 0 ~ 4.6A (convection) +24VDC @ 0 ~ 6.5A (w/ 20.5 CFM)	    

NOTE: There is a significant (~30%) drop difference in performance when cooling by fan-less, natural convection (100~110W) vs. forced convection (fan) cooling (160W) with ≥20.5 CFM See following pages for details to ensure you get what you require.



Features at a Glance:

- Medical safety certified, MOPP level
- Efficient (up to 88%)
- Built-in active PFC function, PF>0.95;
- Remote sense function for 5~15V;
- Remote ON/OFF control; Power good and fail (PG-PF) signal output
- Withstands 300VAC surge for 5 seconds
- Low leakage current <300µA / 264VAC
- No load power consumption < 0.75W
- Protection: Short circuit, Overload, Over voltage, Over temperature
- Certificates: UL / CUL / TUV / CB / CE
- Safety standards: ANSI/AAMI ES60601-1, TUV EN60601-1
- EMC: Extensive including Class B for emissions and Medical Level, Criteria A, for immunity (see following pages)
- MTBF: 230.5 K hrs min. MIL-HDBK-217F (25°C)
- Weight: 0.70 lbs (0.37 Kgs)
- Dimensions: 5.0 x 3.0 x 1.36 inches (LxWxH)
127 x 76.2 x 34.6mm (LxWxH)

3 year warranty

The MED-RPS 160 Series was re-designed to comply with (MOPP level) international medical safety regulations so that they are now suitable for both "patient contact" and "non-patient contact" (MOOP level) medical applications.

The MED-RPS-"G" 160 version is slightly different from the standard model and is specifically enhanced to meet Green Mode energy-saving requirements regulated by Energy Star and EuP. Functions of the "G" version include P.G./ P.F. signal output, built-in remote sense and remote ON/OFF control and a 5V/0.6A standby output. Together with a "no- load power consumption <0.75W," MED-RPS-"G" 160 is suitable for use in "green mode" medical equipment or electric devices that need to meet that energy-saving requirement. MED-RPS-160 series are also suitable for any medical equipment requiring low leakage current.

Pricing:	1 ~ 9	\$ 99.50
	10+	87.00
	25+	78.50

POLLOCK INDUSTRIES, INC. 81 Butternut Road, White River, VT 05001
toll-free 1-866-665-5434 (603) 888-2467 sales@pollock.biz



■ Features :

- Universal AC input / Full range
- Built-in active PFC function
- Protections: Short circuit / Overload / Over voltage / Over temperature
- 5"x3" compact size
- Free air convection for 110W and 160W with 20.5 CFM forced air
- Medical safety approved (2 x MOPP between primary to secondary)(Note.10)
- With power good and fail signal output
- Built-in remote sense function for 5~15V
- No load power consumption under 0.75W by PS-ON control (G model)
- Standby 5V@0.8A with fan, @0.6A without fan (G model)
- 3 years warranty

G: With 5Vsb & no load power consumption < 0.75 W
Blank: Basic function (without 5Vsb)

RPS **G** - 160 - 12



SPECIFICATION

MODEL	RPS□-160-5	RPS□-160-12	RPS□-160-15	RPS□-160-24	RPS□-160-48	
OUTPUT	DC VOLTAGE	5V	12V	15V	24V	48V
	RATED CURRENT (20.5CFM)	30A	12.9A	10.3A	6.5A	3.25A
	CURRENT RANGE (convection)	0 ~ 20A	0 ~ 9.1A	0 ~ 7.3A	0 ~ 4.6A	0 ~ 2.3A
	CURRENT RANGE (20.5CFM)	0 ~ 30A	0 ~ 12.9A	0 ~ 10.3A	0 ~ 6.5A	0 ~ 3.25A
	RATED POWER (convection) Note.7	103W	112.2W	112.5W	113.4W	113.4W
	RATED POWER (20.5CFM) Note.8	155W	159.8W	159.5W	161W	161W
	RIPPLE & NOISE (max.) Note.2	100mVp-p	100mVp-p	120mVp-p	150mVp-p	250mVp-p
	VOLTAGE ADJ. RANGE	CH1:4.5 ~ 5.5V	CH1:10.8 ~ 13.2V	CH1:13.5 ~ 16.5V	CH1:22 ~ 27V	CH1:43.2 ~ 52.8V
	VOLTAGE TOLERANCE Note.3	±4.0%	±3.0%	±3.0%	±2.0%	±2.0%
	LINE REGULATION	±0.5%	±0.5%	±0.5%	±0.5%	±0.5%
LOAD REGULATION	±1.0%	±1.0%	±1.0%	±1.0%	±1.0%	
SETUP, RISE TIME	1800ms, 30ms/230VAC 3500ms, 30ms/115VAC at full load					
HOLD UP TIME (Typ.)	16ms/230VAC/115VAC at full load					
INPUT	VOLTAGE RANGE Note.6	90 ~ 264VAC 127 ~ 370VDC				
	FREQUENCY RANGE	47 ~ 63Hz				
	POWER FACTOR (Typ.)	PF>0.93/230VAC PF>0.98/115VAC at full load				
	EFFICIENCY (Typ.)	85%	87%	87%	87%	88%
	AC CURRENT (Typ.)	2A/115VAC 1.1A/230VAC				
	INRUSH CURRENT (Typ.)	COLD START 35A/115VAC 70A/230VAC				
	LEAKAGE CURRENT Note.9	Earth leakage current < 200 μ A/264VAC , Touch current < 100 μ A/264VAC				
PROTECTION	OVERLOAD	105 ~ 135% rated output power Protection type : Hiccup mode, recovers automatically after fault condition is removed				
	OVER VOLTAGE	5.75 ~ 6.75V	13.8 ~ 16.2V	17.25 ~ 20.25V	27.6 ~ 32.4V	55.2 ~ 64.8V
	OVER TEMPERATURE	110 $^{\circ}$ C (5V), 105 $^{\circ}$ C (12V, 15V, 24V, 48V) (TSW1 : detect on heatsink of power transistor)				
		95 $^{\circ}$ C (5V), 90 $^{\circ}$ C (12V, 15V, 24V, 48V) (TSW2 : detect on heatsink of power transistor) Protection type : (TSW1) Shut down o/p voltage, recovers automatically after temperature goes down Protection type : (TSW2) Shut down o/p voltage, re-power on to recover				
FUNCTION	5V STANDBY (G model)	5VSB : 5V@0.6A without fan, 0.8A with fan 20.5CFM ; tolerance \pm 2% , ripple : 50mVp-p(max.)				
	PS-ON INPUT SIGNAL (G model)	Power on: PS-ON = "Hi" or " > 2 ~ 5V" ; Power off: PS-ON = "Low" or " < 0 ~ 0.5V"				
	POWER GOOD / POWER FAIL	500ms>PG>10ms PF>1ms				
	REMOTE SENSE	5 ~ 15V				
ENVIRONMENT	WORKING TEMP.	-20 ~ +70 $^{\circ}$ C (Refer to "Derating Curve")				
	WORKING HUMIDITY	20 ~ 90% RH non-condensing				
	STORAGE TEMP., HUMIDITY	-40 ~ +85 $^{\circ}$ C , 10 ~ 95% RH				
	TEMP. COEFFICIENT	\pm 0.03%/ $^{\circ}$ C (0 ~ 50 $^{\circ}$ C)				
	VIBRATION	10 ~ 500Hz, 2G 10min./1cycle, 60min. each along X, Y, Z axes				
SAFETY & EMC (Note 4)	SAFETY STANDARDS	ANSI/AAMI ES60601-1, TUV EN60601-1 approved				
	WITHSTAND VOLTAGE	I/P-O/P:4KVAC I/P-FG:2KVAC O/P-FG:1.5KVAC				
	ISOLATION RESISTANCE	I/P-O/P, I/P-FG, O/P-FG:100M Ohms / 500VDC / 25 $^{\circ}$ C / 70% RH				
	EMC EMISSION	Compliance to EN55011 (CISPR11), EN55022 (CISPR22) Class B, EN61000-3-2,-3				
OTHERS	EMC IMMUNITY	Compliance to EN61000-4-2,3,4,5,6,8,11, EN55024, EN60601-1-2, EN61204-3, medical level, criteria A				
	MTBF	230.5K hrs min. MIL-HDBK-217F (25 $^{\circ}$ C)				
	DIMENSION	127*76.2*34.6mm (L*W*H)				
NOTE	PACKING	0.32Kg; 36pcs/12.5Kg/0.79CUFT				
	NOTE	<p>1. All parameters NOT specially mentioned are measured at 230VAC input, rated load and 25$^{\circ}$C of ambient temperature.</p> <p>2. Ripple & noise are measured at 20MHz of bandwidth by using a 12" twisted pair-wire terminated with a 0.1μf & 47μf parallel capacitor.</p> <p>3. Tolerance : includes set up tolerance, line regulation and load regulation.</p> <p>4. The power supply is considered a component which will be installed into a final equipment. The final equipment must be re-confirmed that it still meets EMC directives. For guidance on how to perform these EMC tests, please refer to "EMI testing of component power supplies." (as available on http://www.meanwell.com)</p> <p>5. HS1, HS2 & HS3 can not be shorted.</p> <p>6. Derating may be needed under low input voltages. Please check the derating curve for more details.</p> <p>7. The rated power includes 5Vsb @ 0.6A.</p> <p>8. The rated power includes 5Vsb @ 0.8A.</p> <p>9. Touch current was measured from primary input to DC output.</p> <p>10. Suitable for BF application with appropriate system consideration.</p>				

POLLOCK INDUSTRIES, INC. 81 Butternut Road, White River, VT 05001
toll-free 1-866-665-5434 (603) 888-2467 sales@pollock.biz

Mechanical Specification

Unit:mm

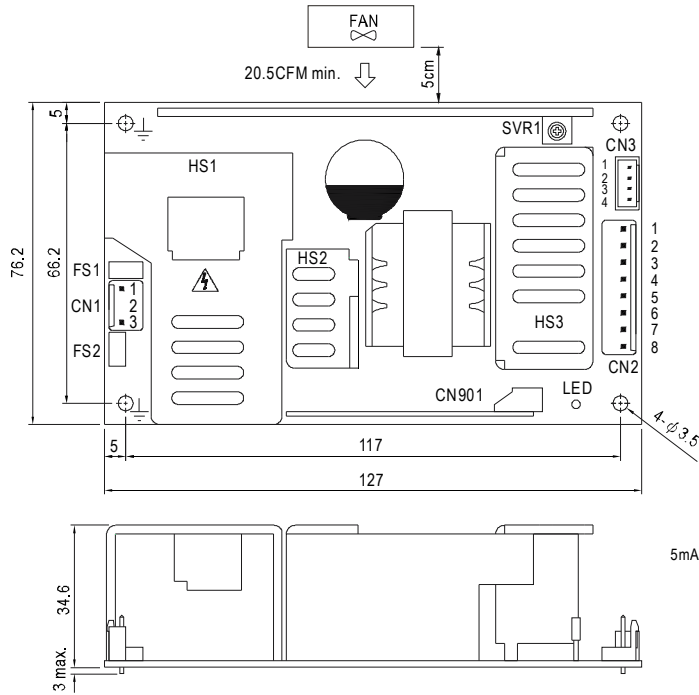

AC Input Connector (CN1) : JST B3P-VH or equivalent

Pin No.	Assignment	Mating Housing	Terminal
1	AC/L	JST VHR or equivalent	JST SVH-21T-P1.1 or equivalent
2	No Pin		
3	AC/N		

DC Output Connector (CN2) : JST B8P-VH or equivalent

Pin No.	Assignment	Mating Housing	Terminal
1,2,3,4	+V	JST VHR or equivalent	JST SVH-21T-P1.1 or equivalent
5,6,7,8	-V		

Power Good Connector(CN3):JST B4B-XH or equivalent

Pin No.	Status	Mating Housing	Terminal
1	PG	JST XHP or equivalent	JST SXH-001T-P0.6 or equivalent
2	GND		
3	-S		
4	+S		

5VSB Connector(CN901) : JST B-XH or equivalent

Pin No.	Assignment	Mating Housing	Terminal
1	PS/ON	JST XHP or equivalent	JST SXH-001T or equivalent
2,4	GND		
3	5VSB		

⚠ HS1,HS2,HS3 can not be shorted

⊕ : Grounding required

Block Diagram

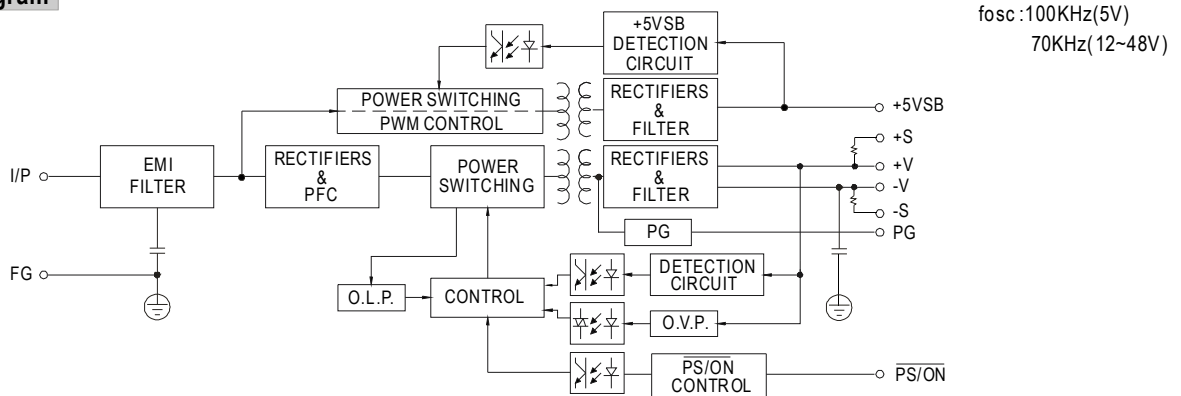

Derating Curve

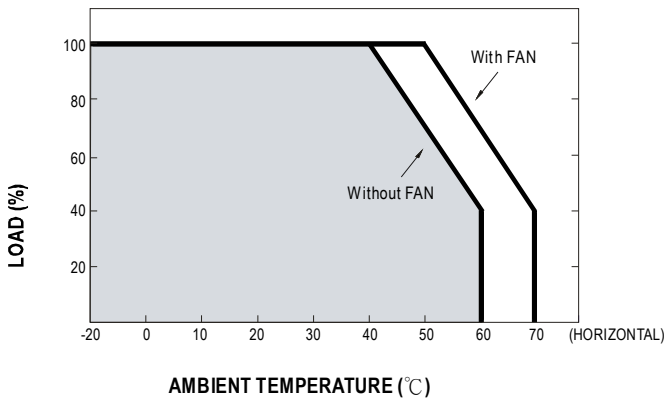

Output Derating VS Input Voltage

