

450 Watt, 12 Volt, Medical Safety Certified  
Single Output Power Supply with PFC

UNIT CODE	DESCRIPTION
MED-PS 450-12V	450 Watt, 12V, Single Output Medical Power Supply with Active PFC Function

SPECIFICATIONS		
AC Input	DC Output	Approvals
Universal AC input 85 ~ 264V	+12VDC @ 0 ~ 37.5A	

### Features at a Glance:

- Medical safety certified, MOOP level
- Efficient (83%)
- Built-in active PFC function, PF>0.95
- Withstands 300VAC surge for 5 seconds
- Low leakage current <300µA/264VAC
- No load power consumption < 0.6W  
Standby 5V @ 0.3A
- Protection: Short circuit / Overload / Over voltage  
Over temperature
- Built-in: Constant current limiting circuit; Remote sense function; Remote ON-OFF control, DC OK signal; Cooling fan ON-OFF control
- 105°C long-life electrolytic capacitors
- Certificates: UL / CUL / CB / CE
- Safety standards: ANSI/AAMI ES60601-1, IEC60601-1 approved
- EMC standards: Class B level  
(see following pages for complete EMC details)
- MTBF: 159.3K hrs min. *MIL-HDBK-217F (25°C)*
- Case: 995A 1U low profile case: 41mm
- Weight: 2.62 lbs (1.19 Kgs)
- Dimensions: 7.83 x 4.13x 1.61 inches (LxWxH)  
218 x 105 x 41mm (LxWxH)
- 5 year warranty



The MED-PS 450 series are high power and highly reliable power supplies designed to meet the rigorous demands of the medical device and equipment market. These are 450 Watt, compact, efficient AC/DC enclosed medical type power supplies that comply with international medical safety regulations (MOOP level).

Standard functions include built-in remote ON/OFF control, protections for short circuit, overload (constant current mode), over voltage, and over temperature. Additionally, with low leakage current ( $\leq 300\mu\text{A}$ ), extremely low no-load power consumption (<0.6W), 1U low profile (41mm). This series meet the high quality requirements for medical applications and are an excellent choice for non-patient contact instruments and equipment. Global certificates of compliance meeting UL/ CUL/ CB/ CE medical safety requirements ensure users' safety. EMI, Class B Level, compliant.

Suitable applications include medical and diagnostic equipment requiring low leakage current such as lab and analysis equipment, monitoring equipment, MRI & X-ray machines, CT Scanners, chemical or biological detection equipment, as well as any system requiring low leakage current and/or low, no-load, power consumption.

[Release & Application Notes](#)

<b>Pricing:</b>	1 ~ 9	\$ 267.00
	10+	254.50
	25+	226.70

POLLOCK INDUSTRIES, INC. 81 Butternut Road, White River, VT 05001  
toll-free 1-866-665-5434 (603) 888-2467 power@electracool.com



### ■ Features :

- Universal AC input / Full range
- Built-in active PFC function, PF>0.95
- High efficiency up to 89.5%
- Withstand 300VAC surge input for 5 seconds
- Protections: Short circuit / Overload / Over voltage / Over temperature
- Built-in constant current limiting circuit
- Medical safety approved (MOOP level)
- Built-in cooling Fan ON-OFF control
- Built-in DC OK signal
- Built-in remote ON-OFF control
- Stand by 5V@0.3A
- Built-in remote sense function
- No load power consumption<0.6W (Note.7)
- 5 years warranty



### SPECIFICATION

MODEL	MSP-450-3.3	MSP-450-5	MSP-450-7.5	MSP-450-12	MSP-450-15	MSP-450-24	MSP-450-36	MSP-450-48		
OUTPUT	DC VOLTAGE	3.3V	5V	7.5V	12V	15V	24V	36V	48V	
	RATED CURRENT	90A	90A	60A	37.5A	30A	18.8A	12.5A	9.5A	
	CURRENT RANGE	0 ~ 90A	0 ~ 90A	0 ~ 60A	0 ~ 37.5A	0 ~ 30A	0 ~ 18.8A	0 ~ 12.5A	0 ~ 9.5A	
	RATED POWER	297W	450W	450W	450W	450W	451.2W	450W	456W	
	RIPPLE & NOISE (max.) Note.2	80mVp-p	80mVp-p	100mVp-p	120mVp-p	150mVp-p	150mVp-p	240mVp-p	240mVp-p	
	VOLTAGE ADJ. RANGE	2.8 ~ 3.8V	4.3 ~ 5.8V	6.8 ~ 9V	10.2 ~ 13.8V	13.5 ~ 18V	21.6 ~ 28.8V	28.8 ~ 39.6V	40.8 ~ 55.2V	
	VOLTAGE TOLERANCE Note.3	±2.0%	±2.0%	±2.0%	±1.0%	±1.0%	±1.0%	±1.0%	±1.0%	
	LINE REGULATION	±0.5%	±0.5%	±0.5%	±0.3%	±0.3%	±0.2%	±0.2%	±0.2%	
	LOAD REGULATION	±1.0%	±1.0%	±1.0%	±0.5%	±0.5%	±0.5%	±0.5%	±0.5%	
	SETUP, RISE TIME	1000ms, 100ms/230VAC      2500ms, 100ms/115VAC at full load								
HOLD UP TIME (Typ.)	16ms/230VAC      16ms/115VAC at full load									
INPUT	VOLTAGE RANGE Note.5	85 ~ 264VAC      120 ~ 370VDC								
	FREQUENCY RANGE	47 ~ 63Hz								
	POWER FACTOR (Typ.)	PF>0.95/230VAC		PF>0.99/115VAC at full load						
	EFFICIENCY (Typ.)	80%	83%	86.5%	88%	89%	88%	89%	89.5%	
	AC CURRENT (Typ.)	5A/115VAC      2.4A/230VAC								
	INRUSH CURRENT (Typ.)	35A/115VAC      70A/230VAC								
	LEAKAGE CURRENT	Earth leakage current < 300 $\mu$ A/264VAC , Touch leakage current < 100 $\mu$ A/264VAC								
PROTECTION	OVERLOAD	105 ~ 135% rated output power Protection type : Constant current limiting, recovers automatically after fault condition is removed								
	OVER VOLTAGE	3.96 ~ 4.62V	6 ~ 7V	9.4 ~ 10.9V	14.4 ~ 16.8V	18.8 ~ 21.8V	30 ~ 34.8V	41.4 ~ 48.6V	57.6 ~ 67.2V	
	OVER TEMPERATURE	Shut down o/p voltage, recovers automatically after temperature goes down								
FUNCTION	5V STANDBY	5VSB : 5V@0.3A ; tolerance ±5%, ripple : 50mVp-p(max.)								
	DC OK SIGNAL	PSU turn on : 3.3 ~ 5.6V ; PSU turn off : 0 ~ 1V								
	REMOTE CONTROL	RC+ / RC-: 4 ~ 10V or open = power on ; 0 ~ 0.8V or short = power off								
	FAN CONTROL (Typ.)	Load 20 ± 10% or RTH2 ≥ 50°C Fan on								
ENVIRONMENT	WORKING TEMP.	-40 ~ +70°C (Refer to "Derating Curve")								
	WORKING HUMIDITY	20 ~ 90% RH non-condensing								
	STORAGE TEMP., HUMIDITY	-40 ~ +85°C, 10 ~ 95% RH								
	TEMP. COEFFICIENT	±0.03%/°C (0 ~ 50°C)								
	VIBRATION	10 ~ 500Hz, 5G 10min./1cycle, 60min. each along X, Y, Z axes								
SAFETY & EMC (Note 4)	SAFETY STANDARDS	ANSI/AAMI ES60601-1, IEC60601-1 approved								
	ISOLATION LEVEL	Primary-Secondary: 2×MOOP, Primary-Earth: 1×MOOP, Secondary-Earth: 1×MOOP								
	WITHSTAND VOLTAGE	I/P-O/P:4KVAC    I/P-FG:2KVAC    O/P-FG:0.5KVAC								
	ISOLATION RESISTANCE	I/P-O/P, I/P-FG, O/P-FG:100M Ohms / 500VDC / 25°C / 70% RH								
	EMC EMISSION	Compliance to EN55011 (CISPR11) Class B, EN61000-3-2,-3								
	EMC IMMUNITY	Compliance to EN61000-4-2,3,4,5,6,8,11, EN60601-1-2								
OTHERS	MTBF	159.3K hrs min.    MIL-HDBK-217F (25°C)								
	DIMENSION	218*105*41mm (L*W*H)								
	PACKING	1.19Kg; 12pcs/15.3Kg/0.82CUFT								
NOTE	<ol style="list-style-type: none"> <li>1. All parameters NOT specially mentioned are measured at 230VAC input, rated load and 25°C of ambient temperature.</li> <li>2. Ripple &amp; noise are measured at 20MHz of bandwidth by using a 12" twisted pair-wire terminated with a 0.1uF &amp; 47uF parallel capacitor.</li> <li>3. Tolerance : includes set up tolerance, line regulation and load regulation.</li> <li>4. The power supply is considered a component which will be installed into a final equipment. The final equipment must be re-confirmed that it still meets EMC directives. For guidance on how to perform these EMC tests, please refer to EMI testing of component power supplies. (as available on <a href="http://www.meanwell.com">http://www.meanwell.com</a>)</li> <li>5. Derating may be needed under low input voltages. Please check the derating curve for more details.</li> <li>6. Length of set up time is measured at first cold start. Turning ON/OFF the power supply may lead to increase of the set up time.</li> <li>7. No load power consumption&lt;0.5W when RC- &amp; RC+ (CN100 pin1,2) 0 ~ 0.8V or short.</li> <li>8. When the input voltage is less than 40VAC, the SPS may exhibit degradation of performance. The final product manufacturers must re-confirm this deviation that does not affect basic safety or essential performance.</li> </ol>									



**Mechanical Specification**

Case No. 995A Unit:mm

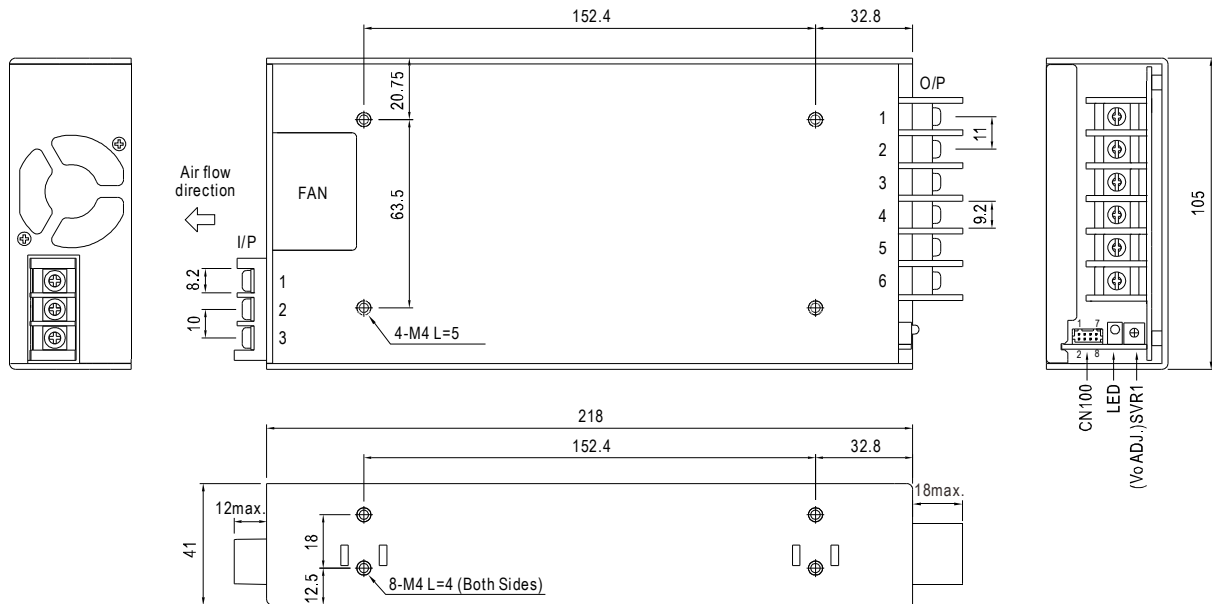

AC Input Terminal Pin No. Assignment

Pin No.	Assignment
1	AC/L
2	AC/N
3	FG $\perp$

DC Output Terminal Pin No. Assignment

Pin No.	Assignment
1-3	-V
4-6	+V

Connector Pin No. Assignment (CN100) : HRS DF11-8DP-2DS or equivalent

Pin No.	Assignment	Pin No.	Assignment	Mating Housing	Terminal
1	RC+	5	DC-OK	HRS DF11-8DS or equivalent	HRS DF11-**SC or equivalent
2	RC-	6	GND		
3	AUX	7	+S		
4	AUXG	8	-S		

**Block Diagram**

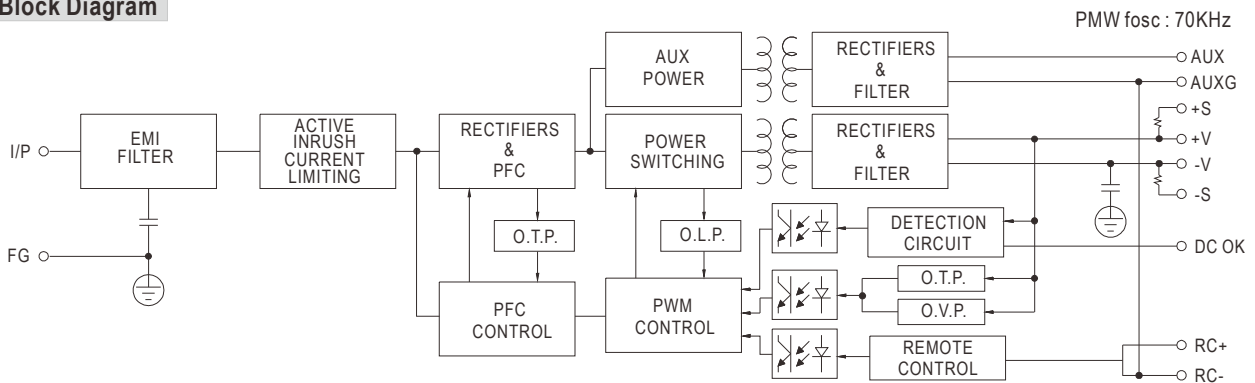

**Derating Curve**

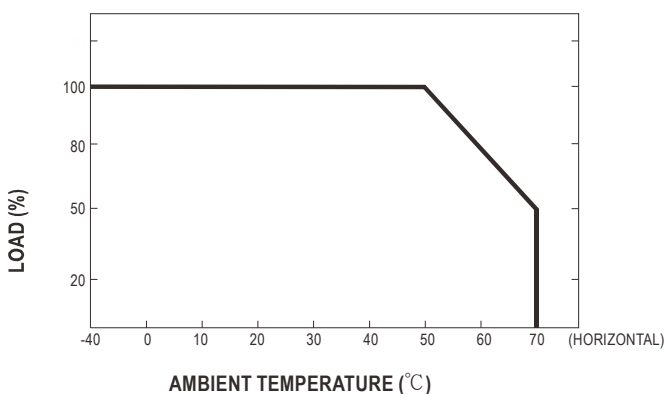

**Output Derating VS Input Voltage**

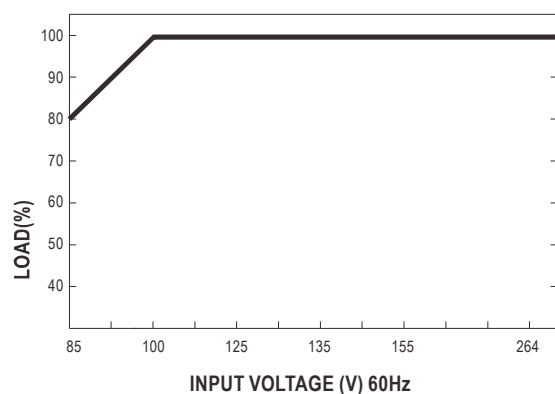

■ **Function Description of CN100**

Pin No.	Function	Description
1	RC+	Turns the output on and off by electrical or dry contact between pin 2 (RC-), Short: Power OFF, Open: Power ON.
2	RC-	Remote control ground.
3	AUX	Auxiliary voltage output, 4.75~5.25V, referenced to pin 4(AUXG). The maximum load current is 0.3A. This output has the built-in oring diodes and is not controlled by the "remote ON/OFF control".
4	AUXG	Auxiliary voltage output ground. The signal return is isolated from the output terminals (+V & -V).
5	DC-OK	DC-OK Signal is a TTL level signal, referenced to pin6(DC-OK GND). High when PSU turns on.
6	GND	This pin connects to the negative terminal(-V). Return for DC-OK signal output.
7	+S	Positive sensing. The +S signal should be connected to the positive terminal of the load. The +S and -S leads should be twisted in pair to minimize noise pick-up effect. The maximum line drop compensation is 0.5V.
8	-S	Negative sensing. The -S signal should be connected to the negative terminal of the load. The -S and +S leads should be twisted in pair to minimize noise pick-up effect. The maximum line drop compensation is 0.5V.

■ **Function Manual**

**1. Remote Sense**

The remote sensing compensates voltage drop on the load wiring up to 0.5V.

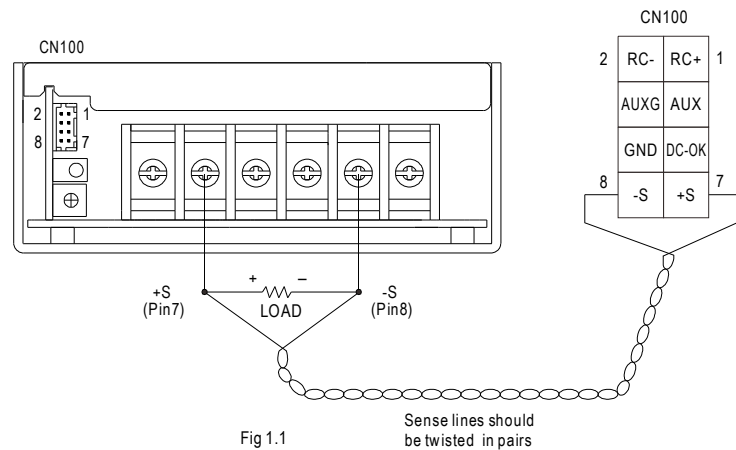

Fig 1.1

**2. DC-OK Signal**

DC-OK signal is a TTL level signal. High when PSU turns on.

Between DC-OK(pin5) and GND(pin6)	Output Status
3.3 ~ 5.6V	ON
0 ~ 1V	OFF

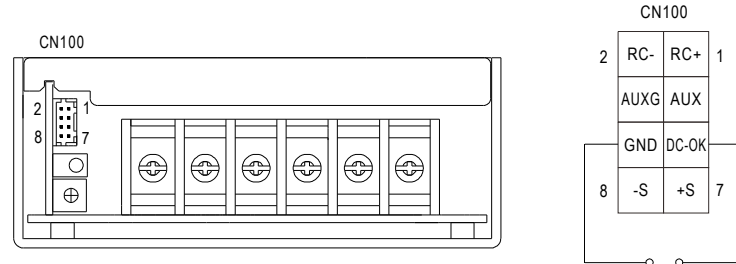

Fig 2.1

**3. Remote Control**

The PSU can be turned ON/OFF by using the "Remote Control" function.

Between RC+(pin1) and RC-(pin2)	Output Status
SW ON (Short)	OFF
SW OFF (Open)	ON

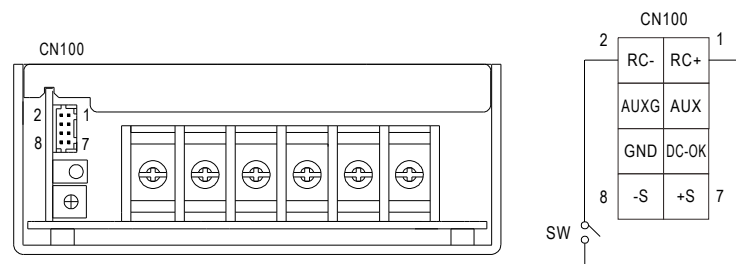

Fig 3.1